

Pilot ID	Intermediate Known									Flight #
----------	---------------------------	--	--	--	--	--	--	--	--	----------

No	Symbol	Cat. No.	K	Total K	Example marks:		Remarks	Pos	Item	K	Grade			
					[7][5]	[0][0]								
					Zeros and Averages:									
					[H][Z]	[P][Z]	[A][V]							
1		7.4.1.1 9.9.3.4	10 11	21					Positioning	30				
2		1.2.7.1 9.4.4.2	13 5	18					Fig K	Total K				
									185	215				
Penalties														
Too Low														
Disqual Fig														
Too High														
Outs														
Interruptions														
Insertions														
Missed Slot														
Trg Violation														
Faulty Wing Rocks														
Final Freestyle														
Duration										Min	Sec			
Judges Details														
Signature														
Name														
Number														
3		7.2.2.1 9.1.3.2 9.2.3.4	6 4 9	19										
4		7.2.3.3 9.9.3.2	6 11	17										
5		8.4.1.1 9.1.1.1	13 6	19										
6		5.2.1.1 9.8.5.1	17 3	20										
7		8.6.1.1 9.1.3.4	11 8	19										
8		7.3.2.1 9.9.2.2 9.2.2.4	14 13 11	38										
9		2.1.2.1	14	14										

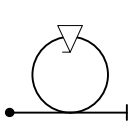

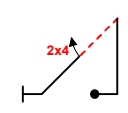
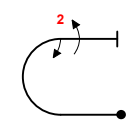
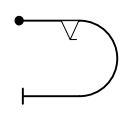
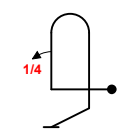
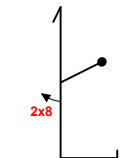
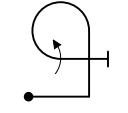
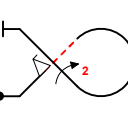
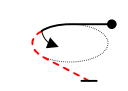

BAeA		2014	FORM B
Pilot ID #	Intermediate Known		Flight #

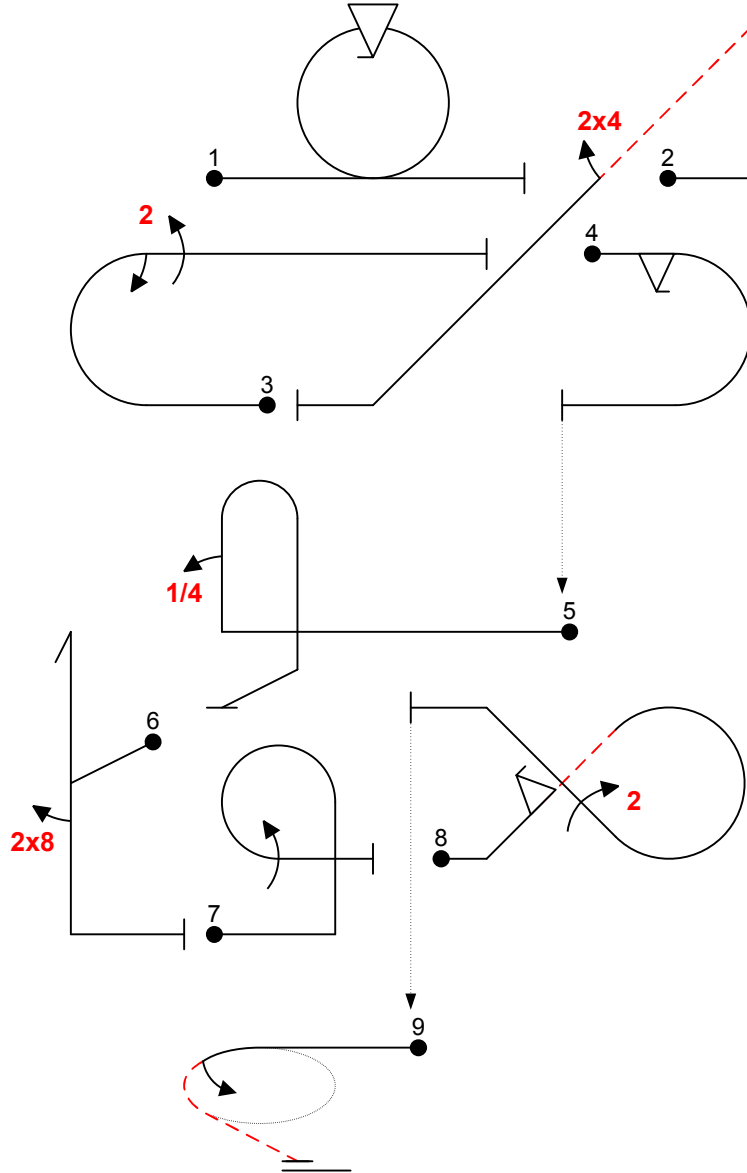
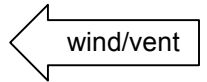

Fig 1	7.4.1.1 9.9.3.4	10 11	21
Fig 2	1.2.7.1 9.4.4.2	13 5	18
Fig 3	7.2.2.1 9.1.3.2 9.2.3.4	6 4 9	19
Fig 4	7.2.3.3 9.9.3.2	6 11	17
Fig 5	8.4.1.1 9.1.1.1	13 6	19
Fig 6	5.2.1.1 9.8.5.1	17 3	20
Fig 7	8.6.1.1 9.1.3.4	11 8	19
Fig 8	7.3.2.1 9.9.2.2 9.2.2.4	14 13 11	38
Fig 9	2.1.2.1	14	14
Total K = 185			

pilot
 A/C
 NAC



BAeA		2014	FORM C
Pilot ID #	Intermediate Known		Flight #

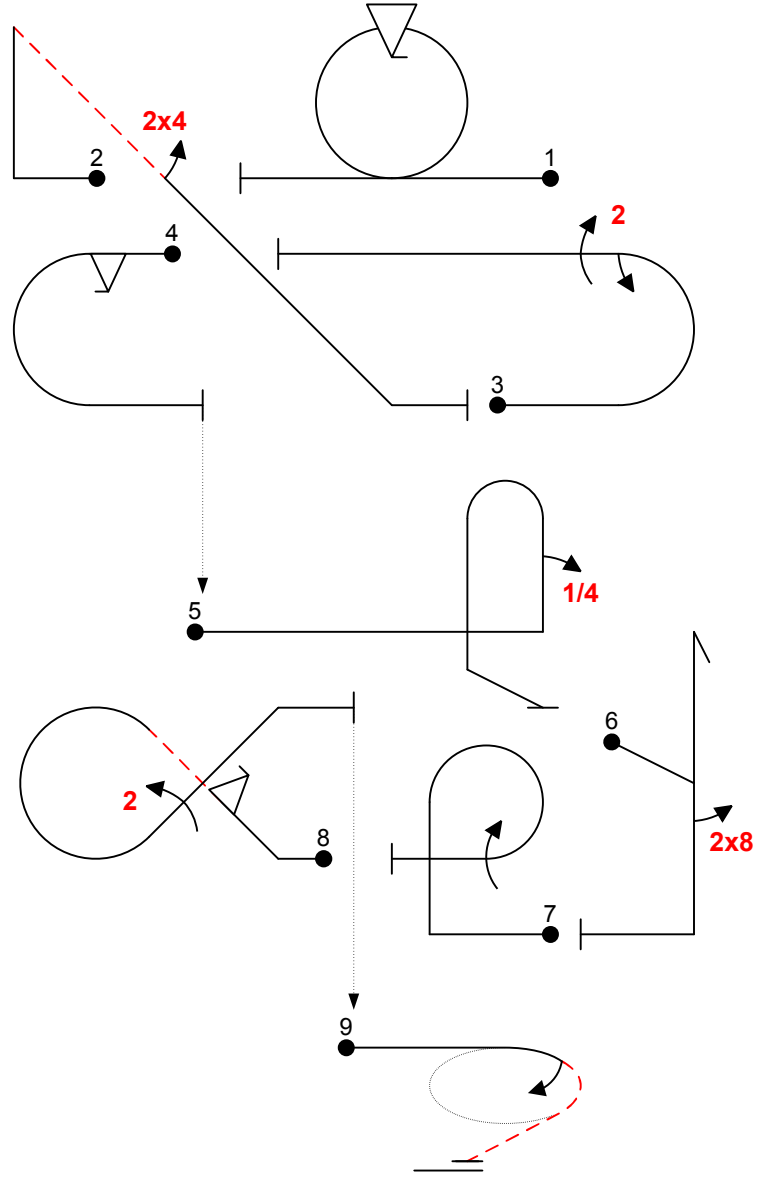

Fig 1	7.4.1.1 9.9.3.4	10 11	21
Fig 2	1.2.7.1 9.4.4.2	13 5	18
Fig 3	7.2.2.1 9.1.3.2 9.2.3.4	6 4 9	19
Fig 4	7.2.3.3 9.9.3.2	6 11	17
Fig 5	8.4.1.1 9.1.1.1	13 6	19
Fig 6	5.2.1.1 9.8.5.1	17 3	20
Fig 7	8.6.1.1 9.1.3.4	11 8	19
Fig 8	7.3.2.1 9.9.2.2 9.2.2.4	14 13 11	38
Fig 9	2.1.2.1	14	14
Total K = 185			

pilot
 NAC
 A/C

wind/vent

